

English translation of the original German Installation,
Operation & Maintenance Manual

Butterfly and Throttle Valves

Type series A and D

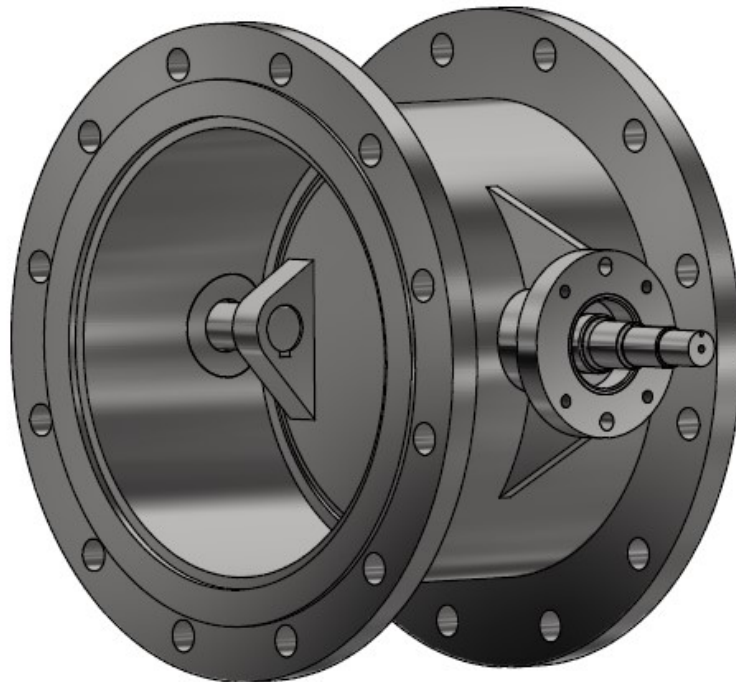

In accordance with EU Pressure Equipment Directive 2014/68/EU
In accordance with EC Machinery Directive 2006/42/EC

CE 2266

© Konrad Armaturentechnik GmbH
Seilfahrt 67
44809 Bochum
GERMANY

Tel.: +49 234 9151700
Fax: +49 234 52660

E-Mail: info@konrad-armaturen.de
Website: www.konrad-armaturen.de

Document ID: BA-AD-EN, version: 2022-11

We are constantly striving to optimise the operating instructions of our products for you.
Therefore, please refer to the latest version on our website at:
www.konrad-armaturen.de/downloads/

1	Information about the IOM	1
1.1	Components of the IOM.....	1
1.2	Copyright	1
1.3	Contents of the operation instructions	1
1.4	Additional information	1
1.5	Signs, abbreviations and terminology	1
1.6	Warnings and safety information	2
1.7	Limitation of liability.....	3
2	Safety	4
2.1	Intended use	4
2.2	Foreseeable misuse	4
2.3	Prohibition of unauthorised modifications	4
2.4	Responsibilities.....	5
2.4.1	Responsibility of the operator	5
2.4.2	Responsibility of personnel.....	5
2.5	Personnel requirements.....	6
2.5.1	Qualifications	6
2.5.2	Training.....	6
2.5.3	Unauthorised individuals.....	6
2.6	Personal protective equipment	7
2.7	Residual risks	7
2.7.1	Risks posed by mechanical hazards.....	8
2.7.2	Risks posed by electrical hazards.....	10
2.7.3	Risks posed by thermal hazards.....	11
2.7.4	Risks posed by noise.....	11
2.7.5	Risks posed by materials and substances.....	11
2.7.6	Risks posed by ignoring ergonomic principles.....	12
2.7.7	Risks posed by naked flames	12
2.8	What to do in the event of danger and accidents.....	13
3	Structure and function	14
3.1	Butterfly valve (type A).....	14
3.2	Throttle valve (type D)	15
3.3	Special equipment	16
3.3.1	With important information for the user.....	16
3.3.2	Without important information required for the user.....	16
3.4	Nameplate	16
4	Transport and storage.....	17
4.1	Safety information on transport.....	17
4.2	Transport inspection	18
4.3	Transport symbols	18
4.4	Attaching and transporting the valve	18
4.4.1	Pallet transport with an industrial truck	19
4.4.2	Pallet transport with lifting equipment	19
4.4.3	Transporting the valve with a lifting vehicle	19

4.5	Storage	21
4.6	Handling packaging	21
5	Installation and commissioning and removal.....	22
5.1	Safety information regarding installation and commissioning	22
5.2	Position in the pipeline	22
5.3	Installation position	23
5.3.1	Course of the pipeline	23
5.3.2	Orientation of the shaft.....	23
5.3.3	Flow and pressure direction	24
5.4	Installation und removal of the valve.....	24
5.4.1	Flanged valves	25
5.4.2	Clamped valves, wafer type.....	25
5.4.3	Valves with butt weld ends.....	26
5.4.4	Valves with a heating jacket (special equipment).....	26
5.5	Actuator connection	26
5.5.1	Manual operation using the handwheel	26
5.5.2	Electric actuator	27
5.5.3	Pneumatic or hydraulic actuator.....	27
5.6	Commissioning	28
5.6.1	Requirements.....	28
5.6.2	Procedure	28
5.6.3	Pressure test.....	28
6	Operation	28
6.1	Safety information regarding operation	28
6.2	Operating the valve.....	29
6.2.1	Manual actuation using the handwheel.....	29
6.2.2	Electric actuator	29
6.2.3	Pneumatic or hydraulic actuator.....	29
6.3	Shutting down in an emergency.....	29
7	Maintenance	30
7.1	Lubricating bearings.....	30
7.2	Gland readjustment.....	31
7.3	Measures after maintenance	31
8	Faults	32
8.1	Procedure in the event of a fault	32
8.2	Troubleshooting	33
8.2.1	Fault table	33
9	Disposal	34
10	List of figures	35
11	List of tables	35
12	Index.....	36

1 Information about the IOM

1.1 Components of the IOM

The following jointly applicable documents belong to these IOM in line with DIN 82079:

- The **technical data sheet**, which has been provided together with the documentation supplied by the manufacturer.
- The **declaration of conformity**, which has been provided together with the documentation supplied by the manufacturer.
- If applicable, the IOM of a component from a third-party manufacturer connected to the valve; e.g. an electric actuator.

Unambiguous assignment is possible using the type name.

1.2 Copyright

The IOM is protected by copyright.

Unauthorised hand-over of these instructions to third parties, reproductions in any form or of any nature, even excerpts, and the exploitation and/or dissemination of the content are not permitted without the written consent of the publisher.

Violations obligate compensation. The right to assert further claims shall remain reserved.

1.3 Contents of the operation instructions

The IOM convey important information on how to handle the valve safely and efficiently.

A precondition for safe working on the valve is compliance with all specified safety information and procedural instructions. Therefore, before commencing any work, personnel must have carefully read and understood this IOM.

The instructions are intended for individuals who are appropriately technically qualified to understand them and carry out the tasks described.

Furthermore, accident prevention regulations and general safety regulations that apply at the location where the valve is being used must be adhered to.

The figures in these instructions are merely intended for basic comprehension and may differ from the actual design of the valves. No claims can be derived from this.

1.4 Additional information

Should you require any further information or have any outstanding questions not covered in this IOM, then please do get in touch with us. You can find our contact details page 2 of this IOM.

1.5 Signs, abbreviations and terminology

Signs, abbreviations and technical terminology are used in this document which have the following meanings:

- Refer to
- Bullet point
- ▶ Procedural instruction (placed before the instruction)
- 1. Procedural step when they are to be carried out in a particular order
- IOM Installation, Operation & Maintenance Manual
- PED DIRECTIVE 2014/68/EU OF THE EUROPEAN PARLIAMENT AND THE COUNCIL of 26 February 2014 for the harmonisation of legal regulations of member states on the provision of simple pressure vessels to the market (the Pressure Equipment Directive)
- PPE Personal Protective Equipment

Abbreviations used on the nameplate → **Section 3.3 Nameplate**

1.6 Warnings and safety information

Warnings and safety information in the instructions are highlighted by pictograms and in a grey-coloured rectangular background. They are also prefaced by signal words which convey the severity of damage.

The warnings and safety information are structured as follows:

SIGNAL WORD!

Source of the danger.

Consequences of ignoring the danger.

- What to do to prevent the danger.

The significance of signal words



DANGER!

... indicates an imminent danger leading to fatality or to serious injuries if it is not prevented.



WARNING!

... indicates a potentially dangerous situation which could cause fatality or serious injuries if it is not prevented.



CAUTION!

... indicates a potentially dangerous situation which could lead to minor injuries if it is not prevented.



ATTENTION!

... indicates potential property damage and harm to the environment and how this can be prevented.

Important safety information

In order to indicate serious dangers, the following pictograms are used in conjunction with the safety information:



... indicates hazards posed by electric current.

If the safety information is ignored, there is a risk of serious or fatal injuries.



... indicates the risk of crushing.

If the safety information is ignored, there is a risk of serious injuries, especially to moving body parts.



... indicates hazards posed by hot surfaces.

If the safety information is ignored, there is a risk of burns and serious skin injuries due to heat.



... indicates dangers posed by hazardous substances that are highly flammable and have a high risk of explosion in work rooms or storage facilities.

If the safety information is ignored, there is a risk of serious injuries or fatality posed by flammable substances catching fire or explosive dusts, gases vapour or mists igniting.

Information about the IOM

- ▶ It is imperative you heed all warnings and safety information!
- ▶ When working, always exercise caution to prevent accidents, injuries and property damage!

Important signs in procedural instructions



Indicates graphical depictions of possible or recommended actions.



Indicates graphical depictions of actions forbidden by the manufacturer.

Tips and recommendations



NOTE!

... highlights tips and recommendations as well as information for efficient and fault-free operation.

1.7 Limitation of liability

All specifications and information in these instructions have been compiled taking applicable standards and regulations as well as our many years of knowledge and experience based on the state of the art into account.

The manufacturer assumes no liability for damage due to:

- Ignoring the instructions
- Improper use
- Deploying insufficiently qualified or untrained personnel
- Unauthorised modifications
- Technical changes
- Use of unapproved spare parts

In the case of additional order options being used, special designs or due to the latest technical changes, the actual scope of supply may differ from the explanations and depictions described here.

The commitments agreed in the delivery contract, the general terms and conditions, the terms of delivery of the manufacturer and the statutory regulations applicable at the time of contract conclusion apply.

We reserve the right to make technical changes as part of improving usage properties and further development.

In case of doubt the original German Installation, Operation and Maintenance Manual shall always apply.

Warranty

The warranty period starts with a defect-free handover. If periods are agreed to which are different from the statutory warranty, you will find these in the order confirmation.

Warranty conditions

The warranty conditions conform with statutory regulations governing warranty in line with the general terms and conditions of the manufacturer. Warranty conditions deviating from this may be agreed to in certain contracts.

Wear parts

Wear parts that are subject to wear even in the course of intended use – such as sealing elements – are exempt from warranty and guarantee claims.

2 **Safety**

This section provides an overview of important safety aspects for the protection of personnel against possible dangers and for safe and fault-free operation.

If the procedural instructions, warnings and safety information presented are ignored, considerable danger could arise.

2.1 **Intended use**

The valve is exclusively intended to be installed and operated in processing facilities. It is used to control the flow of a fluid in a pipeline system.



DANGER!
Danger posed by improper use!

Any use of the valve other than that intended may lead to fatal situations.

- Only use the valve as intended in accordance with the specifications in this IOM especially in compliance with the usage limits stated in the technical data sheet.
→ **Section 1.1 Technical data sheet**
→ **Section 3.4 Nameplate**
- Refrain from any use that goes beyond this or any other type of use of the valve.
- Refrain from reconstruction, retrofitting or changes to the design or of individual equipment parts of the valve.

2.2 **Foreseeable misuse**

The valve may only be used with the known operating parameters.

→ **Section 1.1 Technical data sheet**



DANGER!
Danger posed by misuse!

Misuse of the valve can lead to fatal situations for people and severe property damage.

- Refrain from all misuse of the valve.
- Never climb onto the valve during operation.
- If a valve is equipped with an electric-motor-powered, pneumatic or hydraulic actuator, then the associated – even higher-level – safety equipment must not be deactivated or bypassed.

2.3 **Prohibition of unauthorised modifications**



WARNING!
Danger posed by unauthorised modifications!

Unauthorised modifications to the valve may lead to dangerous situations for people and cause severe damage.

- Refrain from reconstruction, retrofitting or changes to the design or of individual equipment parts of the valve.

2.4 Responsibilities

2.4.1 Responsibility of the operator

Operator

The operator is any natural or juristic person who uses the valve or cedes it to third parties for use and who is responsible for the safety of users, personnel or third parties during use.

Operator's obligations

The valve is used in an industrial environment. The operator of the valve is therefore subject to statutory obligations regarding work safety.

In addition to the warnings and safety information in these instructions, the safety, accident prevention and environmental protection regulations applicable to the area where the valve is used must be complied with.

In particular, the operator must

- learn about applicable work safety regulations.
- identify potential, additional dangers which could result from the specific application conditions at the location where the valve is used by means of a risk assessment.
- lay out the necessary rules of conduct for the operation of the valve at the location of use in IOM.
- regularly check throughout the whole time the valve is used that the IOM authored by the operator conform to the latest standards, rules and regulations.
- adjust the IOM, if required, to new regulations, standards and usage conditions.
- clearly and unambiguously delegate responsibilities for the installation, maintenance and cleaning of the valve.
- ensure that all employees occupied with the valve have read and understood this IOM. Furthermore, the operator must train personnel at regular intervals on how to handle the valve and notify them of possible dangers.
- provide personnel charged with work on the valve with the prescribed and recommended protective equipment and ensure constant compliance with the obligation to wear it. → **Section 2.6**
- ensure the required open spaces and adequate lighting for safe working, as well as constant cleanliness and tidiness at the set-up location of the valve and its surroundings.

Furthermore, the operator is responsible for the valve

- only being used as intended → **Section 2.1**
- always being kept in a technically flawless condition.
- being serviced in line with specified maintenance information. → **Section 7**
- all the valve's safety equipment regularly being checked for completeness and functionality.

2.4.2 Responsibility of personnel

The valve is used in an industrial context. Personnel are therefore subject to statutory obligations regarding work safety.

In addition to the warnings and safety information in these instructions, the safety, accident prevention and environmental protection regulations applicable to the area of use must be complied with.

In particular, personnel

- must have read in full and have understood the IOM prior to commencing work.
- follow the IOM of the operator.
- fulfill the assigned responsibilities for the operation, maintenance and cleaning of the valve.

- learn about the applicable work safety regulations, especially regarding use of the prescribed and recommended protective equipment.

Furthermore, everybody occupied with the valve is to ensure within the scope of their responsibilities that the valve

- is always kept in technically flawless condition.
- is serviced in line with specified maintenance instructions.
- all the valve's safety equipment is regularly checked for completeness and functionality.

2.5 Personnel requirements

2.5.1 Qualifications

Specialist personnel

Specialist personnel are individuals extensively and verifiably instructed by the operator on the tasks assigned to them and possible dangers, and who possess the necessary technical qualifications.

Expert personnel

Expert personnel are individuals who have garnered and demonstrated in-depth experience, knowledge and skills for safely performing activities in specific technical fields (e.g. electricians, hydraulics, pneumatics, welding, cargo securing).



WARNING!

If personnel are insufficiently qualified, there is a risk of injury and property damage!

Working incorrectly can lead to significant injury or property damage.

- The valve must exclusively be transported, installed, operated and serviced by specialist personnel.
- Specialised work may only be performed by qualified specialist personnel.
- Individuals whose responsiveness is compromised – e.g. due to drugs, alcohol or medicines – must not perform any work.

- ▶ When deploying personnel, always comply with the age-related and occupation-specific regulations applicable at the location of use.

2.5.2 Training

Every user must be instructed by the operator on the activities assigned to them and possible dangers during working prior to starting work. A user is anyone performing any activity on the valve.

Before commencing any work, all users must have carefully read and understood these IOM.

- ▶ Repeat training at regular intervals.
- ▶ Record all personnel training in a verifiable manner.
- ▶ Keep the IOM in a location accessible to the user.

2.5.3 Unauthorised individuals



WARNING!

Risk of injury to unauthorised individuals

Unauthorised individuals are not aware of the dangers in the work area of the valve and may severely injure themselves and others.

- Unauthorised individuals must not enter the work area of the valve.
- If in doubt, address the individuals concerned and direct them out of the work area of the valve.
- Stop working when unauthorised individuals are in the work area of the valve.

Safety

An unauthorised individual is anybody who

- has not read this IOM, not read them in full or who has not understood them properly.
- does not meet the necessary qualification requirements for activities on the valve.
- has not received any training for their activities on the valve and/or has not been charged with those activities by the operator or its representatives.

2.6 Personal protective equipment

Wear for all work



Protective workwear

Tight-fitting workwear with low tear resistance, with narrow sleeves and without any protruding parts, primarily for protection against getting caught on moving valve parts.

Do not wear any rings, chains or other jewellery.



Safety shoes

For protecting feet against injuries caused by parts falling down and against slipping and falling on slippery surfaces.

Wear for specific work

For certain work (e.g. welding), the wearing of specific protective workwear and additional protective equipment is required. This is specifically pointed out in the sections of the instructions.



Industrial helmets

For protection against head injuries due to parts or materials falling down or flying around.



Hearing protection

For protection against hearing damage.



Protective gloves / heat-protection gloves

For protecting hands against abrasion, grazes, scratches, scrapes, pricks and similar skin injuries and against burns in the event contact with hot surfaces.



Facial protection

For protecting the eyes and the face against process gases, flames, sparks or embers, as well as hot particles or waste gases.

2.7 Residual risks

The valve has been subjected to a risk assessment. The risks and dangers determined in this process have been eliminated or minimised as much as possible. Nevertheless, the valve poses residual risks which are described in the following section.

- ▶ It is imperative you heed the warnings and safety information presented here and in the procedural sections of these instructions in order to prevent potential harm to health and dangerous situations.

2.7.1 Risks posed by mechanical hazards



Risk of crushing posed by moving components



WARNING!
Risk of crushing!

Moving components can crush body parts during operation!

- If necessary, set up a danger zone; do not enter during operation.
- Always perform installation and maintenance work as well as troubleshooting with particular care and attention paid to crushing points.
- Place the valve disc in a slightly opened position prior to transport and removal of the valve.





Risk of injury during maintenance work



WARNING!
Risk of injury posed by unauthorised activation/reactivation!

When working on components, assemblies or individual parts, individuals at danger points may get injured by unauthorised activation/reactivation of the power supply.

- Shut the valve down prior to commencing work.
- Secure the valve against unauthorised activation (e.g. with a warning sign on the control system).





Compressed air



WARNING!
Risk of injury posed by compressed air!

In the event of damage, malfunctions or incorrect operation, air can discharge under high pressure from lines or individual components and lead to severe injuries; e.g. to eyes.

- Only have work on components carrying compressed air performed by expert personnel.
- Prior to commencing maintenance or servicing work, block off the compressed air system, shut it down and secure it against reactivation. Depressurise components carrying compressed air. Completely depressurise pressure accumulators.
- Never change pressure settings beyond the maximum permitted values.





Pressure hoses



CAUTION!
Risk of injuries posed by defective or old pressure hoses!

Defective pressure hoses and connections, or ones that have become porous through ageing, can burst and lead to injuries due to a sudden release of pressurised fluids.

- Regularly check all pressure hoses and their connections by visual inspection sure they are in a technically flawless condition, have firm connections, and do not show any signs of leak points, cracks or external damage.
- If defects are identified, shut down the valve immediately and arrange for pairs by expert personnel.
- Do not reuse pressure hoses that have already been used.
- When replacing pressure hoses, make sure that the new pressure hose is adequately dimensioned and designed for the loads arising in the pressure





Pressure lines and components



WARNING!
Risk of injury from pressurised lines and components!

When working on pressurised lines and components as well as in the event of damage to pressure lines or components, fluids can discharge under high pressure and cause injuries.

- Work may only be performed by expert personnel.
- Prior to commencing work, first depressurise the pressure system and pressure accumulators and check the pressure system is depressurised.
- Always comply with the permitted pressure settings.
- If leaks or damage are detected on pressure lines or components, immediately shut the valve or switch it off and secure it against reactivation.



Lifting and transport operations



DANGER!
Risk of fatality during lifting and transport operations!

Falling loads or their parts can kill people.

- Only use lifting and transport devices, sling gear and support and securing equipment when it is in a technically flawless condition and has adequate load-bearing capability.
- Prior to commencing any lifting and transport operations, check the attached is fixed securely and the support and securing equipment is working reliably.
- Only ever undertake lifting and transport operations under the guidance and instruction of a supervisor.
- Only ever have lifting and transport operations performed by expert personnel.
- Never stand under suspended loads.
- If necessary, set up a danger zone; do not enter during operation.



Working on elevated components



DANGER!
Risk of falling!
Risk of injury due to falling objects!

In the event of work on elevated components, unsecured individuals may fall down or people may get injured by falling objects.

- When working on components at height, always use a stable ladder or work platform with railings.
- Secure people, tools, equipment, spare parts and all loose objects at height against falling down.
- If necessary, set up a danger zone; do not enter during operation.
- Do not climb onto the valve during operation.

Sharp edges and pointed corners



CAUTION!
Risk of injury from edges and corners!

Sharp edges and pointed corners can cause grazes, scrapes and cuts.

- When working near to sharp edges and pointed corners, always exercise caution.



Dirt and objects lying around



CAUTION!
Risk of tripping posed by dirt and untidiness!

Dirt and objects lying around constitute sources of slipping and tripping and can lead to significant injuries.

- Always keep the work area clean and tidy.
- Clear away tools and objects that are not required.

2.7.2 Risks posed by electrical hazards

Electric current

When operating the valve with an electric actuator

→ **Section 1.1 Technical data sheet**



WARNING!
Risk of fatality posed by electric current!

Touching live parts can lead to fatality. Damage to the insulation or individual components can be fatal.

- Prior to commencing work on the electrics, disconnect the electrical system from the power supply. Ensure there is no voltage!
- Prior to maintenance, cleaning and repair work, disconnect the electrical power supply and secure against reactivation.
- If the insulation is damaged, switch off the power supply immediately and arrange for repairs.
- Do not bypass or disable fuses.
- When replacing defective fuses, always pay attention to the correct amperage rating.
- Keep live parts away from moisture and humidity.
- All work on the electrical system must strictly only be performed by expert personnel.





2.7.3 Risks posed by thermal hazards

Hot operating materials

When conveying hot fluids or when fitting the valve with a heating jacket.



→ Section 1.1 Technical data sheet

	<p>WARNING! Risk of burns due to hot operating materials!</p> <p>Hot operating materials or fluids can cause burns when coming into contact with skin.</p> <ul style="list-style-type: none"> – Wear appropriate protective workwear for all work. – Prior to handling operating materials, measure their temperature; if necessary, allow operating materials and containers to cool down to below +50°C. – Pay attention to the flow temperatures of hot fluids (e.g. water vapour); allow components to cool down to below +50°C. – If necessary, set up a danger zone; do not enter during operation. 	 
---	---	--

Hot surfaces



When conveying hot fluids or when fitting the valve with a heating jacket:

→ Section 1.1 Technical data sheet

	<p>CAUTION! Risk of burns posed by hot surfaces!</p> <p>Contact with hot components can cause burns.</p> <ul style="list-style-type: none"> – During all work near hot components, wear the appropriate protective workwear, especially heat-protection gloves. – Prior to all work, allow hot components to cool down to below +50°C. – If necessary, set up a danger zone; do not enter during operation. 	 
---	--	--



2.7.4 Risks posed by noise

Noise

	<p>CAUTION! Hearing impairments due to noise!</p> <p>Noise may occur during certain work which could lead to temporary hearing impairments.</p> <ul style="list-style-type: none"> – Always pay attention to warning signs. 	
---	--	---

2.7.5 Risks posed by materials and substances

Hazardous substances

	<p>WARNING! Risk of injury when handling hazardous substances!</p> <p>Hazardous substances can lead to poisoning or skin irritation.</p> <ul style="list-style-type: none"> – Pay attention to the safety data sheet and information from the manufacturer or operator. – Avoid shaking and spraying. – No eating, drinking or smoking during work. – Avoid contact with the skin and eyes. 	 
---	---	--

2.7.6 Risks posed by ignoring ergonomic principles

Unhealthy posture; severe straining



CAUTION!

Harm to health due to unhealthy posture!

Incorrect lifting of heavy components and an unnatural posture during working can cause health complaints.

- Always lift heavy components with the help of several people.
- Always perform work on components situated low down in a squat position – not bent over.
- When kneeling, use knee protection; when sitting, use cushions.
- When working on components situated high up, assume a straight, upright posture when working.
- Use tools in a technically flawless condition which are suitable for carrying out work safely when performing all work.

2.7.7 Risks posed by naked flames

Hot or flammable fluids



WARNING!

Risk of injury posed by naked flames!

When conveying fluids with high temperatures or flammable fluids, naked flames may arise.

- Regularly check the valve for leaks and eliminate them where necessary.
→ **Section 8**
- Always keep the valve clean. Remove processing residues, waste, dirt, empty containers, cloths, etc. after completing work.
- Do not store any empty or full packaging or loose materials in between spaces or on parts and components.
- Lubricate bearings in line with maintenance specifications in short intervals appropriate to loads to avoid overheating.
- Inspect electrical installations regularly to ensure their flawless condition. Have defective installations and devices repaired immediately by specialist electrical personnel or replace them.
- In the case of operation in an ATEX area: Conduct an ignition source analysis!
- If necessary, set up a danger zone; do not enter during operation.



Welding work



WARNING!

Risk of fire and injury posed by welding work!

Spattering welding beads can cause injuries or ignite materials.

- Set up a danger zone; do not enter without specific PPE during operation.
- Wear PPE specifically suited for welding or soldering work! → **Section 2.6**
- Set up a welding location for welding or soldering work in line with local safety regulations.
- Shut/switch off the valve and secure it against reactivation.
- Remove flammable materials and objects from the area surrounding the welding location.
- Seal up open grease and oil lines and ports.
- Clean all lubricating points thoroughly of oil and grease residues.
- Protect possible fire sources from spattering welding beads.

Keep fire extinguishers at the ready at the welding location.



2.8 What to do in the event of danger and accidents

Preventive measures

- ▶ Always be prepared for accidents and fires.
- ▶ Keep first-aid equipment (first-aid boxes, blankets, etc.) and fire extinguishers at the ready.
- ▶ Familiarise personnel with accident-reporting, first-aid and rescue equipment.
- ▶ Clear access routes for rescue vehicles.

Correct procedure in these instances

1. Trigger the emergency stop immediately.
2. Initiate first-aid measures.
3. Recover affected people from the danger zone.
4. Notify managers at the location of use.
5. In the event of serious injury, call a doctor and/or the fire brigade.
6. Clear access routes for emergency vehicles.

3 Structure and function

3.1 Butterfly valve (type A)

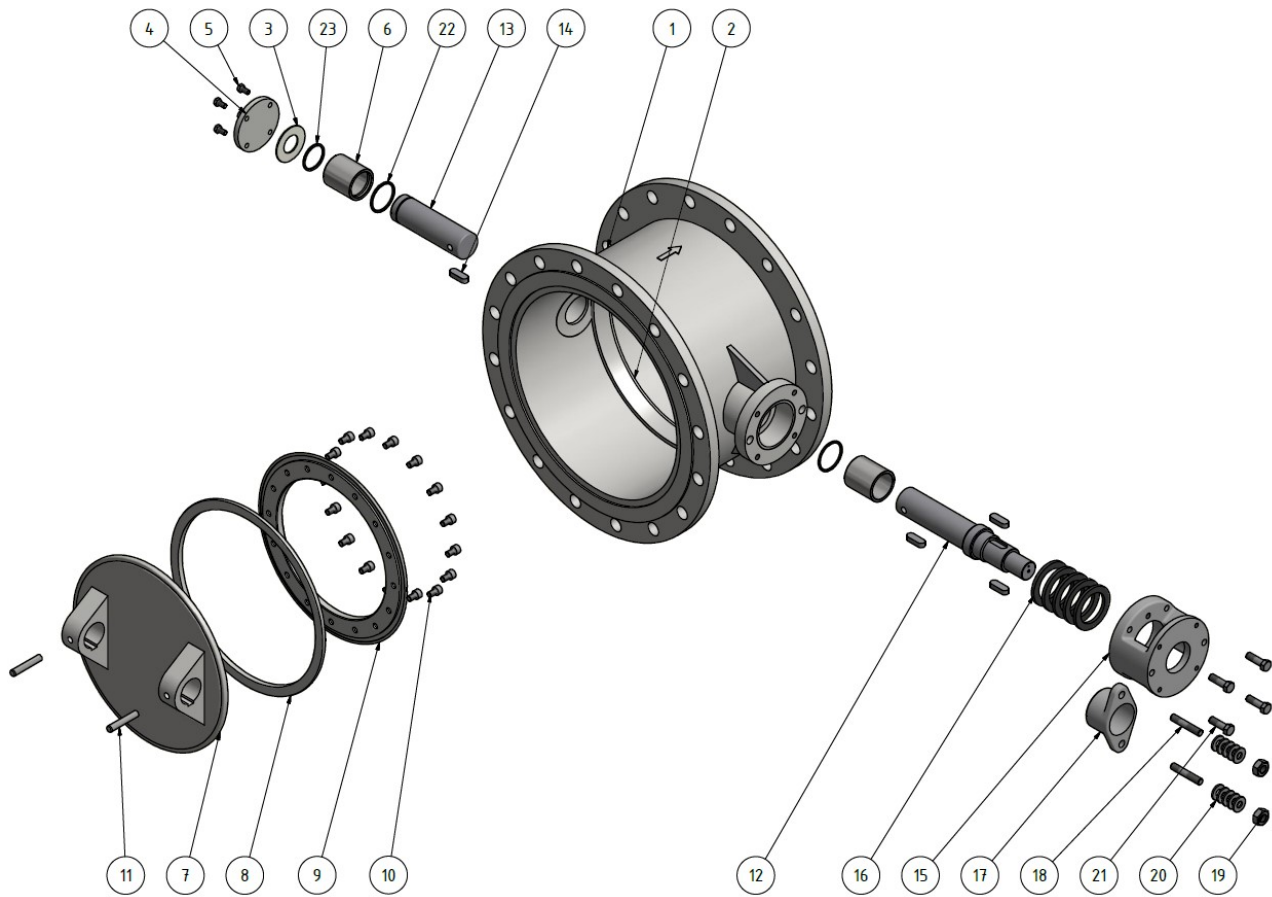

Figure 3-1: Example illustration of a butterfly valve

1	Valve body	12	Drive shaft
2	Seat ring	13	Countershaft
3	Cover gasket	14	Parallel key
4	Cover	15	Intermediate spacer
5	Screw	16	Glandpacking
6	Bearing bush	17	Gland flange
7	Valve disc	18	Stud bolt
8	Disc seal ring	19	Nut
9	Retaining ring	20	Spring washer
10	Screw	21	Screw
11	Grub screw	22	O-ring
		23	O-ring

Table 3.1-1: Parts list for the butterfly valve

Structure and function

Function description

Butterfly valves are shut-off devices in pipelines that let fluid pass through and stop the flow.

The secure and durable sealing is achieved through the low-friction closing of the valve disc with seal ring into a conical body seat. The valve disc is driven either by a gear with a handwheel, an electric actuator, a pneumatic (type A-Pn) or a hydraulic (type A-Hy) actuator. A variable speed drive can also be selected (type AR) for the installation of an electric actuator. When installing a pneumatic actuator, for reasons of safety, a spring-opened/closed function can also be included (type AS).

3.2 Throttle valve (type D)

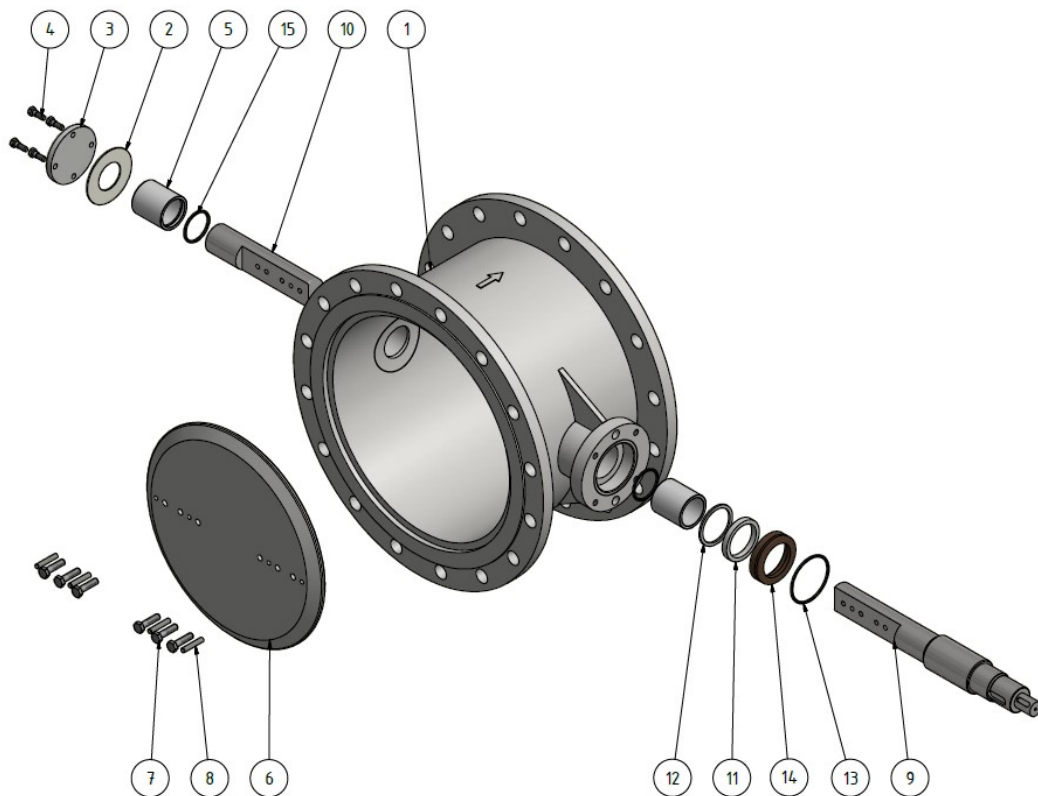

Figure 3-2: Example illustration of a throttle valve

1	Valve body	9	Drive shaft
2	Cover gasket	10	Countershaft
3	Cover	11	U-seal
4	Screw	12	Thrust washer
5	Bearing bush	13	O-ring
6	Valve disc	14	U-seal holder
7	Screw	15	O-ring
8	Dowel pin		

Table 3.2-1: Parts list for the throttle valve

Function description

Throttle valves are regulating devices in pipelines that influence the rate of fluid flow.

Secure and durable sealing is not the objective of its use. The valve disc is driven the same way as described for type A.

→ Section 3.1

3.3 Special equipment

→ Section 1.1 Technical data sheet

3.3.1 With important information for the user

- Heating jacket / heated shaft → Section 5.4.4
- Limit stop (stroke limitation) → Section 5.4
- Grease block chamber → Section 7.1
- Gland packing → Section 7.2
- Surface protection: rubber lining → Section 4.5

3.3.2 Without important information required for the user

Butterfly and throttle valves are available with special equipment which do not require any important information for handling safety or the installation and operation of the valve over its service life. For this reason, they are not cited or dealt with separately in this IOM.

They include:

- Thrust bearings → Section 5.3.2
- Outer bearings
- Flow protection (for protecting the valve disc seal ring against abrasion caused by erosive fluids)
- Surface protection: Special paint

3.4 Nameplate

A nameplate is affixed to every valve which contains the information required by the PED:

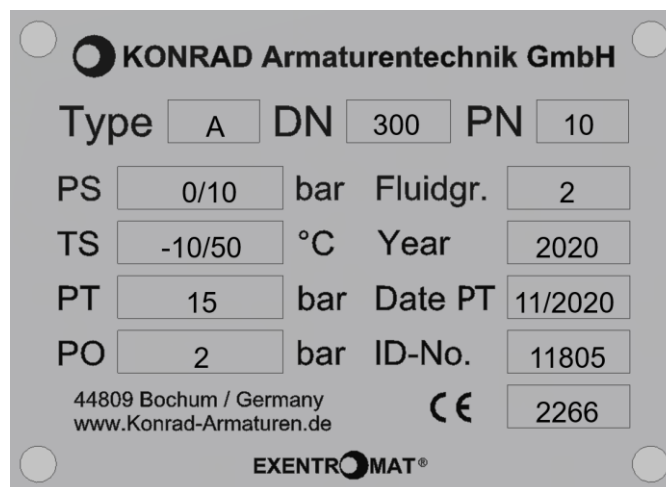

Figure 3-3: Nameplate

Transport and storage

Text	Description
Type	Type name of the manufacturer
DN	Nominal size
PN	Nominal pressure (connection design)
PS	Design pressure / min./max. permitted pressure
TS	Design temperature / min./max. permitted temperature
PT	Test pressure for strength testing, hydrostatic
PO	Operating pressure
Fluid gr.	Fluid group as per PED
Year	Year of construction
Date PT	Pressure test date
ID no.	Manufacturing number / ID number of the valve
CE	Identification number of the notified body (depending on PED category)

Table 3.4-1: Details of the nameplate

4 Transport and storage

4.1 Safety information on transport

Personnel

- ▶ Have transport work exclusively performed by expert personnel.
- ▶ Transport work performed using lifting or conveying equipment requiring supervision must only be performed by trained specialist personnel authorised for its operation and charged with this task by the operator.

Personal protective equipment

→ Section 2.6



DANGER!

Risk of fatality posed by falling loads!

Falling loads or their parts can kill people.

- Never stand under suspended loads
- Do not enter the slewing range of lifting equipment during operation
- Always wear a protective helmet during crane work



WARNING!

Risk of injury posed by slewing transported goods!

Transported goods with an eccentric centre of gravity can swing out heavily upon being raised and seriously injure people close by.

- Leave ample space for the slewing range of lifting equipment prior to raising transported goods
- Pay attention to transport information and symbols on the transported goods
- Always wear a protective helmet during crane work



DANGER!

Risk of fatality posed by crushing!

Dangerous crushing can occur when positioning or setting down transported goods.

- Prior to setting transported goods down, make sure that no people or body parts of people are in the target area
- Always wear a protective helmet during crane work
- Seal off the area



ATTENTION!

Property damage caused by incorrect lifting and transporting!

Attaching loads incorrectly, inadequate transport safeguards and poor positioning of the components can cause severe damage to the transported goods and to objects nearby.

- Only ever perform lifting and transport operations while in strict compliance with the instructions in this IOM!
- Pay attention to the information and symbols on the packaging
- Only remove transport safeguards at the time of installation

4.2 Transport inspection

Upon receipt of the delivery, immediately check the condition of the transported goods for their completeness and for any damage.

In the event of any externally identifiable transport damage:

- ▶ Do not accept the delivery, or only conditionally so.
- ▶ Record the extent of the damage in the transport documents and make a note on the delivery note of the freight forwarder.
- ▶ Raise a complaint.



NOTE!

Raise all defects immediately upon receipt of the transported goods! Damage claims concerning transport damage can only be asserted if complaints are raised immediately.

4.3 Transport symbols

Symbols corresponding to the contents are located on the outside of the transported goods. It is imperative these symbols are heeded during transport and storage.



NOTE!

If further transport is intended at a later point in time, store away the original packaging and reuse it, or use appropriate transport containers and materials equivalent to the original packaging. It is imperative that the necessary symbols and markings are reattached to the transported goods so they are clearly visible.

Meaning of the transport symbols



Up

- ▶ The tips of the arrows indicate the top of the transported goods. They must point upwards; otherwise, the contents can become damaged.



Fragile

- ▶ Handle the transported goods with care; do not let them fall and do not subject them to impact.



Keep dry

- ▶ Protect the transported goods from moisture and keep them dry.

4.4 Attaching and transporting the valve

- ▶ Always raise and set down the transported goods slowly and carefully.
- ▶ Pay attention to the centre of gravity of the transported goods during every type of transportation.

Transport and storage

4.4.1 Pallet transport with an industrial truck

Transported goods on pallets or skids can be transported with an industrial truck (e.g. a forklift) under the following conditions:

- The industrial truck must be designed for the transport weight.
- The transported goods must be secured on the pallet against slipping and tipping over.
- When transporting using a pallet, remember that the transported goods can also protrude beyond the pallet.

4.4.2 Pallet transport with lifting equipment

Transported goods on pallets or skids can be transported with lifting equipment under the following conditions:

- The lifting equipment and the sling gear must be designed for the transport weight.
- The transported goods must be secured on the pallet against slipping and tipping over.
- Sling gear such as ropes, straps or multiple-point suspension gear must be attached to the pallet so that it is suspended horizontally; correct this if necessary.
- The sling gear must not damage the transported goods. If necessary, keep the sling gear away from the transported goods using edge protection strips or wooden beams.
- When transporting using a pallet, remember that the transported goods can also protrude beyond the pallet.

4.4.3 Transporting the valve with a lifting vehicle

Valves with suitable attachment points can be transported directly with lifting equipment under the following conditions:

- The lifting equipment and the sling gear must be designed for the transport weight.
- The valve has suitable attachment points: crane lugs, flange holes, holes in the neck bearing or clamping ribs, neck bearing with flanges.
- The sling gear must not damage the transported goods. If necessary; keep the sling gear away from the transported goods using suitable protective materials.

► Attach ropes, straps or multiple-point suspension gear according to the figures below.

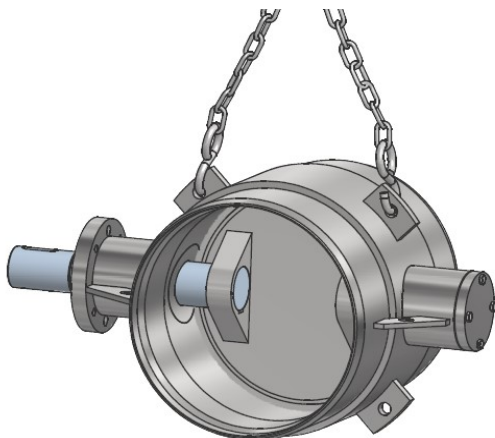

Figure 4-1: Attachment to the crane lugs



Figure 4-2: Attachment to the flange holes



ATTENTION!

Property damage caused by incorrect lifting and transporting!

- Under no circumstances may the valve be attached at the actuator!

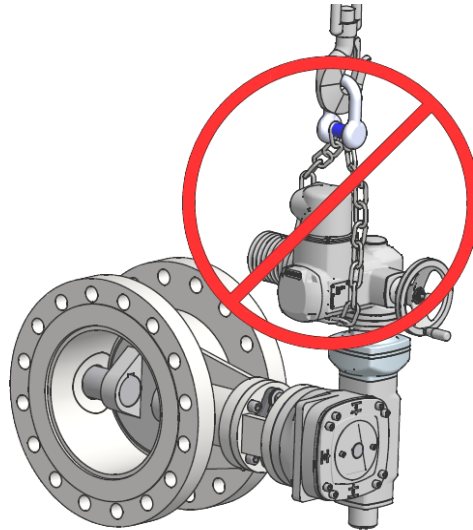

Figure 4-3: Attachment to the actuator



ATTENTION!

Property damage caused by incorrect lifting and transporting!

- Under no circumstances may the sling gear be routed through the body.

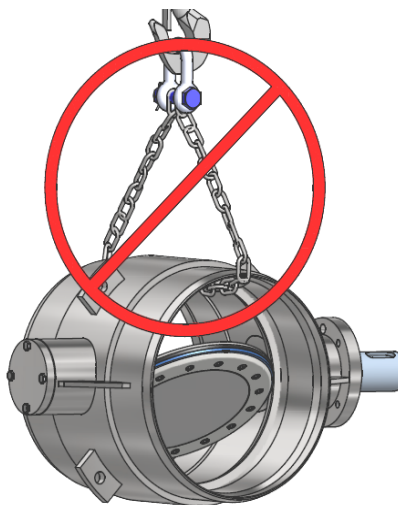

Figure 4-4: Attachment through the valve body

Transport and storage

4.5 Storage



WARNING!

Risk of crushing posed by the valve tipping over!

- Be aware that the valve must be stored so that it is secured against tipping over. Pay attention to the centre of gravity during this process!
- If necessary, heed additional or deviating storage information which could be located on the transported goods!



ATTENTION!

Unsuitable set-up location / moisture!

Material damage can be incurred due to the influence of weather.

- Store the valves in a closed hall!
- Protect the valve from dirt!
- Protect electrical components in particular from moisture!



ATTENTION!

Property damage due to excessively long and/or incorrect storage!

Due to excessively long and/or incorrect storage, seals made of elastomers can lose their original properties and impair the function of the valve.

The same applies to valves with surfaces with rubber lining.

- Pay attention to DIN 7716 (regulations regarding the storage of elastomers)!

4.6 Handling packaging

The transported goods are securely packaged in an environmentally friendly manner for the anticipated transport conditions. The packaging protects the components against damage and corrosion up to the start of installation.

- ▶ Only remove packaging and transport safeguards prior to installation.
- ▶ Dispose of packaging material according to the applicable local regulations.



ATTENTION!

Environmental damage due to incorrect disposal!

Packaging materials are valuable raw materials and can be reused or be practically reconditioned and recycled.

- Always dispose of packaging material in an environmentally friendly manner
- Pay attention to local regulations. If necessary, commission a specialist company with disposal

5 Installation and commissioning and removal

5.1 Safety information regarding installation and commissioning



WARNING!

Dangers posed by incorrect installation and commissioning!

Installation faults can lead to fatal situations.

- Make sure that the valve to be installed is suitable for the operating parameters of the field of application in question
- Have all installation and initial commissioning work exclusively performed by expert personnel with extensive experience
- The intended operation by the operator following all the specifications in this IOM is only permitted after conducting recorded test runs.

5.2 Position in the pipeline

- In order to prevent increased wear, the valve should be installed as far away as possible from a pipe bend or a pump, because a laminar flow only re-emerges after a distance of approx. **5 x DN** behind such a flow-influencing element.

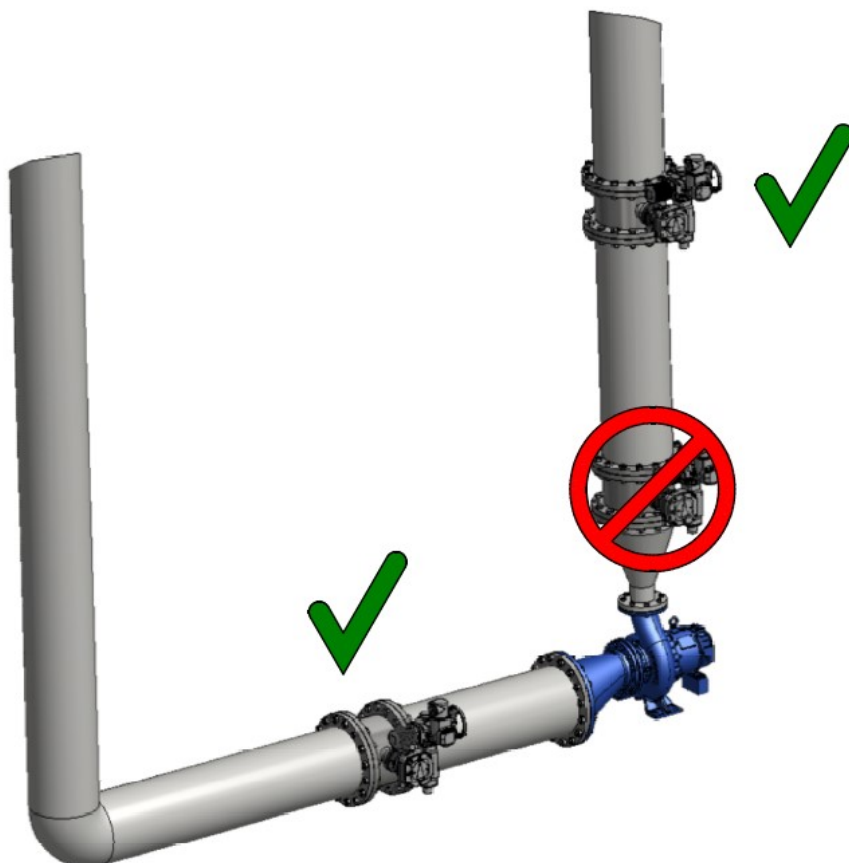

Figure 5-1: Position in the pipeline / 1

Installation and commissioning and removal

- ▶ To ensure deposits do not impair flawless functioning, the valve should not be installed in a dip.

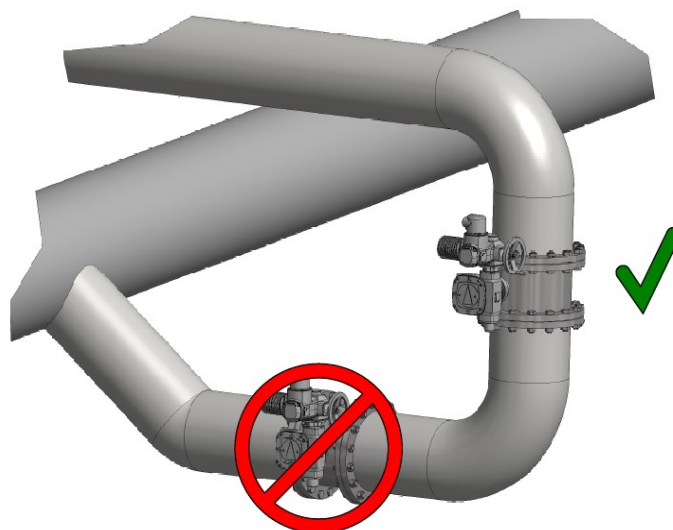

Figure 5-2: Position in the pipeline / 2

5.3 Installation position

5.3.1 Course of the pipeline

Installation of the valve is possible in a pipeline running both horizontally and vertically.

- ▶ When installing in a horizontally or vertical pipeline, pay attention to the orientation of the shaft!

5.3.2 Orientation of the shaft

- ▶ The valve will ideally be installed so that the shaft is horizontal (horizontal orientation of the shaft).



ATTENTION!

A vertical orientation of the shaft is only permitted if the valve has a **thrust bearing** as special equipment. → **Section 3.3.2**

The flawless functioning of the valve cannot be guaranteed if the installation instructions are not followed.

5.3.3 Flow and pressure direction

The arrow direction on the body indicates the pressure direction so that, as a rule, the pressure is on the shaft side! The flow is permitted in both directions.

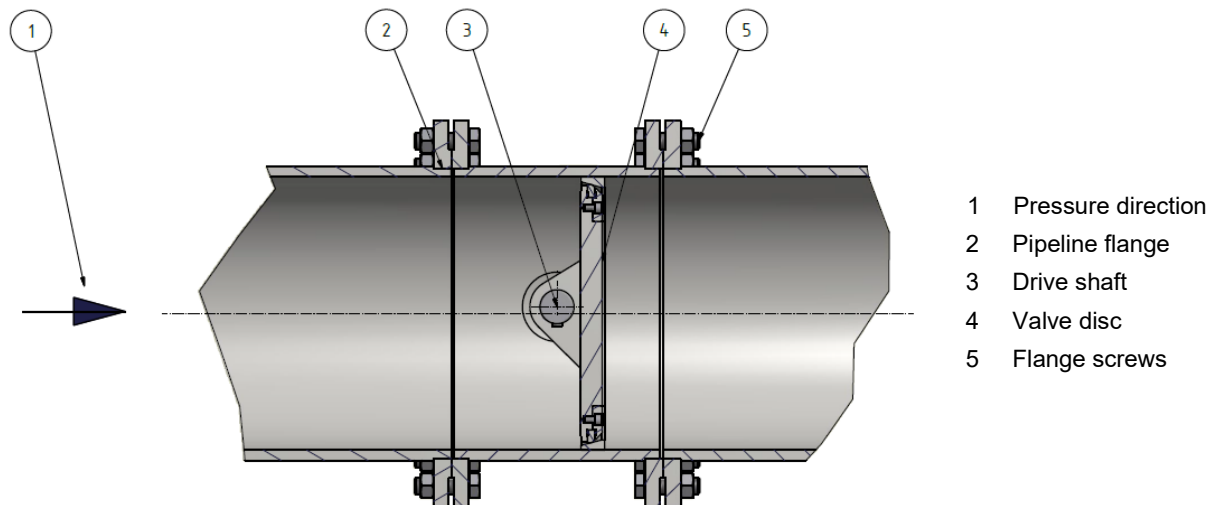

Figure 5-3: Butterfly valve cross section

5.4 Installation und removal of the valve



WARNING!
Risk of injury posed by pressurised lines!

Installation work may only be performed by trained specialist personnel. Installation faults can lead to fatal situations.

- Have all installation work performed by trained specialist personnel
- Stop all fluid flow through the pipelines
- Perform depressurisation and residue emptying; if necessary, allow cool-down periods
- Secure against repressurisation

► Prior to installation, the pipeline, the flanges, the contact areas in the case of welding, the valve disc seal ring and the body seat ring are to be checked for dirt and cleaned if necessary.



ATTENTION!
Property damage due to incorrect handling of valves with rubber lining!

If the surface with rubber lining is damaged, the protective function of the rubber lining is no longer ensured.

- Only use tools with the greatest care during transport and installation activities
- Do not perform transport and installation activities at temperatures below 0°C, because rubber lining is particularly sensitive to mechanical influences at low temperatures

Installation and commissioning and removal



NOTE!

The valve disc must be in a slightly opened position (the delivered condition).
The position of the valve disc is indicated on the gear cover.



NOTE!

For valves with **stroke limitation**, the limit stop is set at the factory and must not be changed.

- ▶ Pay attention to the pressure arrow on the valve body! The direction of the arrow indicates the direction of pressure.
Fluid flow is permitted in both directions.
- ▶ Bring the valve into position in accordance with the aforementioned information on transport → **Section 4.4** and installation position → **Section 5.3**.



ATTENTION!

Only install the valve between parallel pipeline flanges and without stress

5.4.1 Flanged valves

1. Bring the valve into position and fix it (e.g. using load-bearing equipment, screw clamps, etc.).
2. Check the parallel position of the pipeline flange; the screw hole openings must match up.
3. Position suitable flange seals (follow the installation instructions of the manufacturer).
4. Insert suitable flange screws (→ **Section 1.1 Technical data sheet**); attach washers and, if necessary, spring washers and nuts and fasten them diagonally with a wrench so they are finger-tight.
5. Check alignment; correct if necessary and fasten flange screws diagonally with a torque wrench.
6. If necessary, connect the actuator → **Section 5.5**.
7. To check the installation is correct, carefully establish pipeline pressure.
The valve is now ready for operation.

Removal

To remove the butterfly valve, proceed in reverse order to the above.

5.4.2 Clamped valves, wafer type

1. Bring the valve into position and fix it (e.g. using load-bearing equipment, screw clamps, etc.).
2. Check the parallel position of the pipeline flange; the screw hole openings must match up.
3. Position suitable flange seals (follow the installation instructions of the manufacturer).
4. Insert threaded rods through the holes of the pipe flange; attach washers and, if necessary, spring washers and nuts and fasten them diagonally with a wrench so they are finger-tight.
5. Check alignment; correct if necessary and fasten threaded nuts diagonally with a torque wrench.
6. If necessary, connect the actuator → **Section 5.5**.
7. To check the installation is correct, carefully establish pipeline pressure.
The valve is now ready for operation.

Removal

To remove the butterfly valve, proceed in reverse order to the above.

5.4.3 Valves with butt weld ends

1. Bring the valve into position and fix it (e.g. using load-bearing equipment, screw clamps, etc.).
2. Weld the body to the pipeline → **Section 1.1 Technical data sheet**



ATTENTION!

Property damage due to hot temperatures!

The seal seat can warp due to high temperatures during welding and the valve will leak.

- The seal seat in the body must be cooled down from outside during welding.

Note: this does not apply to throttle valves!

1. If necessary, connect the actuator → **Section 5.5**.
2. To check the installation is correct, carefully establish pipeline pressure.
The valve is now ready for operation.

Removal

A welded valve can only be removed without destroying it by flame-cutting it from the pipeline or through metal cutting. This places specific requirements on personnel and should only be performed by expert personnel.

5.4.4 Valves with a heating jacket (special equipment)

In the event of large temperature differences between the surroundings and the fluid, a heating jacket can be used. The jacket itself has heating fluid flowing through it, which is temperature-controlled, thus stabilising the desired temperature of the fluid.

The heating jacket is connected to the heating fluid supply in accordance with the connection data.

→ **Section 1.1 Technical data sheet**

5.5 Actuator connection

5.5.1 Manual operation using the handwheel

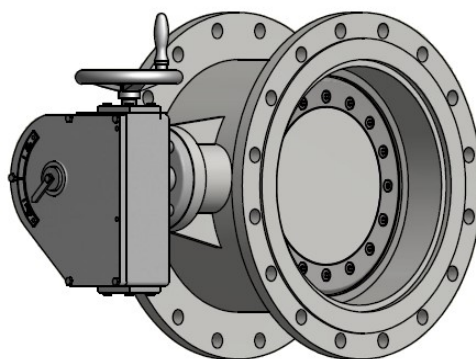

Figure 5-4: Butterfly valve with manual actuator using a handwheel

With a manual actuator using a handwheel, no specific measures are needed. The valve is ready for operation immediately after installation.

Installation and commissioning and removal

5.5.2 Electric actuator

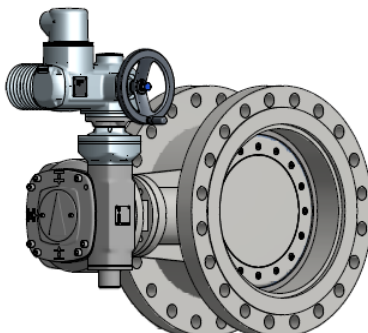

Figure 5-5: Butterfly valve with electric actuator

Electric actuators installed at the factory are always set up ready for connection.

- ▶ The connection must only be performed by expert personnel.
- ▶ For the connection to the system's control units, please follow the IOM of the actuator manufacturer, which form part of this IOM (→ **Section 1.1**). Above all make sure that there is a power connection present which corresponds with the performance data of the actuator.
- **Section 1.1 Technical data sheet**
- ▶ Always remember that the CLOSED and OPEN end positions are factory-set by the travel-dependent switches. Torque-dependent switches shall not be changed, which can lead to damage or malfunctions.

5.5.3 Pneumatic or hydraulic actuator

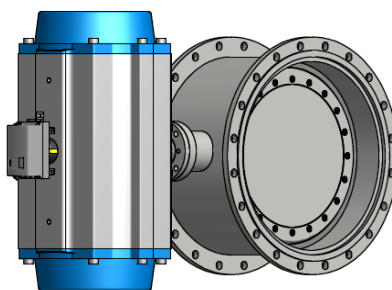

Figure 5-6: Butterfly valve with pneumatic actuator

Factory-installed pneumatic or hydraulic actuators are always set ready for direct connection.

- ▶ The connection must only be performed by expert personnel.
- ▶ For the connection to the system's control units, please follow the IOM of the actuator manufacturer, which form part of this IOM (→ **Section 1.1**). Above all make sure that there is a pneumatic/hydraulic connection present which corresponds with the performance data of the actuator.
- **Section 1.1 Technical data sheet**
- ▶ Make sure that the ambient temperature and the maximum control air/hydraulic pressure does not exceed the specifications of the IOM of the actuator manufacturer.

- ▶ When installing accessories such as valves and limit switches, make sure that these devices are attached so that they are protected against water, dirt and mechanical damage.

5.6 Commissioning

5.6.1 Requirements

In order to be able to put the valve into operation for the work process, the following conditions must be fulfilled:

- The valve has been installed successfully. → **Section 5.4**
- The electrical, pneumatic or hydraulic connections have been established. → **Section 5.5**
- If necessary, a danger zone has been set up and marked. → **Section 2.7**
- No personnel are in the danger zone.

5.6.2 Procedure

- ▶ Slowly establish the operating condition in line with the underlying parameters (→ **Section 1.1 Technical data sheet**) and inspect the valve for any possible leaks, loose connections, vibrations or other signs of improper functioning.
- ▶ If necessary, stop the commissioning process and check that the installation work has been performed properly.

5.6.3 Pressure test

- ▶ For the pipeline pressure test, you must ensure the following at room temperature:
During the pressure test, the pressure PT specified on the nameplate (→ **Section 3.4 Nameplate**) must not be exceeded.
- ▶ For a pipeline pressure test at different temperatures, please refer to DIN EN 12266-1.

6 Operation

6.1 Safety information regarding operation



WARNING!

Risk of injury due to incorrect operation!

Incorrect installation and operation can lead to severe injuries.

- Installation and commissioning must only be performed by trained personnel authorised to do so by the operator.
- Prior to all work, ensure that all safety equipment is correctly installed and functioning flawlessly.
- Never disable protective equipment.
- Always ensure tidiness in the work area! Materials not intended for processing which are lying around and unnecessary objects and tools are sources of accidents.



WARNING!

Risk of injury posed by moving components!

Moving components can cause severe injuries.

- Prior to commencing work, secure the danger zone from access with a barrier on all sides and mark it clearly.
- Do not stand in the danger zone when the system is running.
- Do not disable safety equipment.
- Prior to working at danger points, first wait for overrunning system parts to come to a standstill.



WARNING!

Risk of injury to unauthorised individuals

Untrained individuals are not aware of the dangers posed by the valve and can injure themselves severely.

- Seal off the danger zone of the system to guard against access by unauthorised individuals.
- Constantly monitor the danger zone during system operation and ensure that nobody is in it.
- Keep unauthorised individuals away. In cases of doubt, address the individuals in question and direct them out of the danger zone.
- Stop work on and with the system while unauthorised individuals are in the danger zone.

6.2 Operating the valve



NOTE!

The position of the valve disc is indicated on the gear cover.

6.2.1 Manual actuation using the handwheel

- ▶ Close the drive by turning the handwheel in a clockwise direction.
- ▶ Open the drive by turning the handwheel in an anticlockwise direction.

6.2.2 Electric actuator

- ▶ For valve operation using an electric actuator, please follow the IOM of the actuator manufacturer, which form part of this IOM (→ **Section 1.1**).

6.2.3 Pneumatic or hydraulic actuator

- ▶ For valve operation using a pneumatic or hydraulic actuator, please follow the IOM of the actuator manufacturer, which form part of this IOM (→ **Section 1.1**).



NOTE!

The valves are components of an overall system and – if electric, pneumatic or hydraulic actuators are used with other work processes – are often controlled from a control panel/room. Programming and integration are performed by the operator.

6.3 Shutting down in an emergency

In dangerous situations, fluid flow must be stopped as quickly as possible and the power supply must be switched off.

In the event of danger

1. Notify managers at the location of use.
2. Depressurise the pipeline system.
3. Shut the valve if possible.
4. If necessary, turn off the main switch and secure it against reactivation.
5. If necessary, call a doctor and the fire brigade.
6. Recover injured people; initiate first-aid measures.
7. Clear and secure access route for rescue vehicles.

Following rescue measures

1. If necessary, notify the relevant authorities.
2. Charge specialist personnel with troubleshooting.
3. Before putting the valve back into operation, check its technical condition thoroughly and make sure that all safety devices are properly reinstalled and functional again.

7 Maintenance

As a rule, valves in the designs supplied by Konrad Armaturentechnik GmbH are low maintenance. Maintenance work is required in the special cases cited below.

For all valves, depending on the location of installation, you should regularly

- remove dirt, if necessary.
- check the external coat for damage and repair it if necessary.
- check the valve for possible leaks. → **Section 8**

7.1 Lubricating bearings

For valves with a grease block chamber: → **Section 1.1 Technical data sheet**

For dirty fluids, the bearings are equipped with cover rings and designed as a grease block chamber. These bearings each have one lubricating nipple on the neck bearings of the drive shaft and countershaft, through which the block chambers are to be lubricated depending on operating requirements (approx. every six months).

Use a grease that is classified in line with DIN 51502 and has a viscosity of NLG / grade 2.

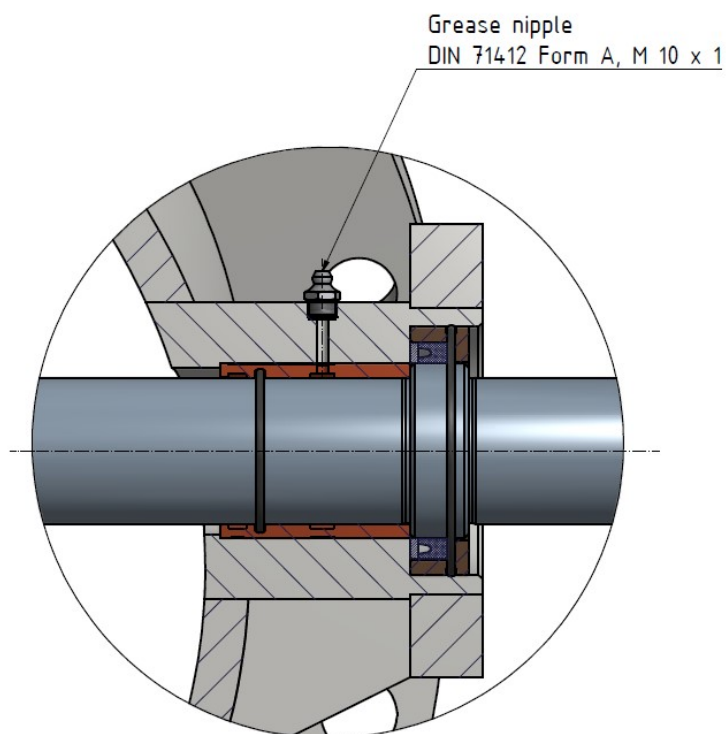

Figure 7-1: Grease block chamber

7.2 Gland readjustment

For valves with gland packing: → Section 1.1 Technical data sheet

Depending on the operating parameters, in particular at high fluid temperatures, gland packings may be used as shaft seals.

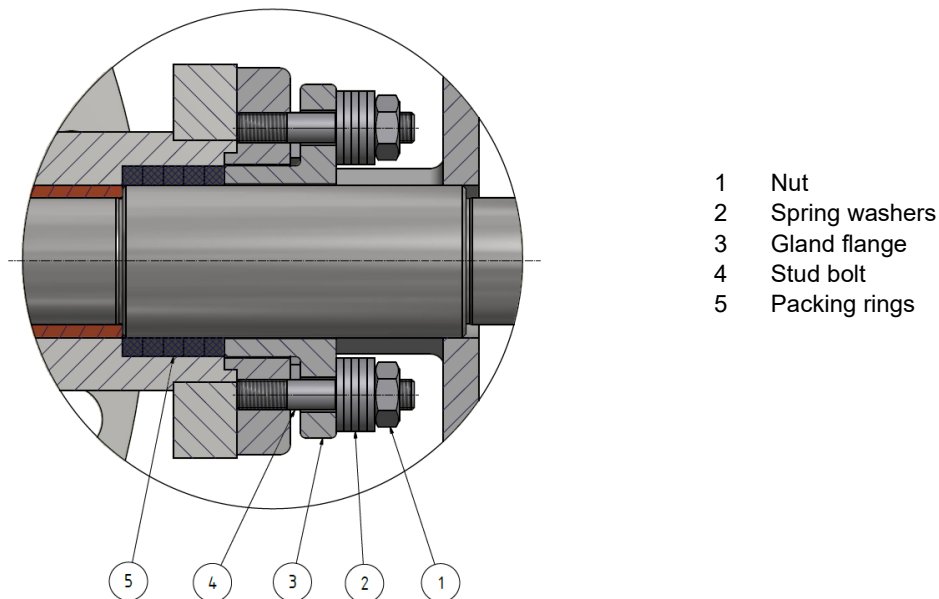

Figure 7-2: Gland

The gland packing can be readjusted in the event of a leak. The glands are set at the factory and pre-tensioned (equally on both sides) so that they are tight for the known operating parameters.

Depending on the size, the gland has a readjustment range of approx. 4–10 mm. The gland flange should therefore only be readjusted moderately and equally on both sides. It is possible to add individual rings.

→ In the event of a leak, take the following steps:

1. Move the actuator to the OPEN and CLOSED direction so that the shaft moves and the gland packing rings slide.
2. Readjust the gland equally on both sides and tighten both nuts until leak-tightness is established.

7.3 Measures after maintenance

Once maintenance work is complete and prior to activation, perform the following steps:

1. Check if all previously loosened screw connections are firmly tightened.
2. Check that all previously removed protective devices and covers are properly reinstalled.
3. Ensure that all used tools, materials and other equipment has been removed from the work area.
4. Clean the work area and remove any substances that may have discharged; e.g. fluids, processing materials or suchlike.
5. Ensure that all the system's safety equipment is working properly.

8 Faults



WARNING!
Risk of injury posed by incorrect troubleshooting!

Performing work incorrectly during troubleshooting can lead to severe injuries.

- Repair work must only be performed by trained specialist personnel authorised by the operator to do so.
- Only ever perform work when the valve is at a standstill.
- Depressurise the pipeline system.
- Prior to commencing all work, turn off the power supply and secure the valve against reactivation.
- Ensure adequate installation space prior to starting work.
- Always ensure cleanliness and tidiness in the work area! Objects, components, workpieces, tools and cleaning devices that are lying around are a source of accidents.
- If components have been replaced, check correct installation of the spare parts. Install all fixing elements properly. Comply with screw tightening torques.
- Prior to recommissioning, ensure that all protective equipment is correctly installed and is functional.
- Prior to reactivation, ensure nobody is in the danger zone.



WARNING!
Risk of injury posed by incorrect spare parts!

Faulty spare parts can severely compromise safety and cause damage, malfunctions and even fatalities.

- Strictly only use original spare parts!

8.1 Procedure in the event of a fault

1. In the case of faults that pose an immediate danger to people or property, trigger the emergency-stop function of the entire pipeline system immediately.
2. Turn off all power sources and secure against reactivation.
3. Notify managers at the location of use.
4. Depending on the type of fault, determine the cause from competent and authorised specialist personnel and have it eliminated.

Faults

8.2 Troubleshooting



NOTE!

As a rule, butterfly and throttle valves in the designs supplied by us are low maintenance. If faults arise which cannot be remedied by the measures described, get in touch with the manufacturer to coordinate necessary measures for specific cases.

Konrad Armaturentechnik GmbH
Seilfahrt 67
44809 Bochum, Germany
GERMANY

Tel.: +49 23 452 635
Fax: +49 23 452 660

Email: info@konrad-armaturen.de
Website: www.konrad-armaturen.de

- Only commission individuals with troubleshooting who have been extensively instructed by the manufacturer in terms of the structure and functionality of the system, have been trained for the necessary tasks and who have been authorised to fulfil these tasks by the operator in accordance with the specifications in this IOM.

8.2.1 Fault table

Valve type	Fault	Possible cause	Measure
A	Valve disc leaking	Foreign objects in the flow	Open and close the valve several times; ideally with the fluid flowing
		Valve is not fully closed	Turn the handwheel clockwise In the case of electric actuators: check torque and travel settings In the case of pneumatic, hydraulic or electric actuators: check the functionality of the actuator
		Body seat or disc seal damaged	Servicing at the manufacturer
A, D	Leaks on the shafts	Sealing elements are worn due to increased stress or ageing	For valves with gland packings: readjust gland packing (→ Section 7.2) if necessary, servicing at the manufacturer
A, D	Valve disc cannot be moved	Drive defective	Contact the valve manufacturer
A	Valve disc cannot be opened	Valve is jammed due to closing force	Deinstall valve from the pipeline and release the valve disc mechanically from the seat; check setting actuator; if necessary, in consultation with the valve manufacturer.

			<p>Use the handwheel for its intended purpose. Do not generate any impermissibly high torque!</p> <p>In the case of electric actuators: check torque and travel settings</p> <p>In the case of pneumatic, hydraulic or electric actuators: check the functionality of the actuator</p>
		Valve is jammed due to foreign objects in the seat	Deinstall valve from the pipeline and release the valve disc mechanically from the seat; remove foreign objects

Recommissioning after a fault

After troubleshooting or fault resolution:

1. Reset the emergency-stop mechanisms.
2. Acknowledge fault message or fault on the control system.
3. Make sure nobody is in the danger zone.
4. Start in accordance with the information in the section 6 "Operation".

9 Disposal



ATTENTION!

Environmental damage due to incorrect handling of hazardous substances!

Incorrect or negligent use of hazardous substances can lead to serious environmental pollution.

- Always dispose of all hazardous substances in line with local regulations; commission a specialist company if necessary.

After deinstallation, the valves should be sent for recycling, which is possible for almost 100% of the materials used.

The operating materials to be disposed of during service life must be disposed of in accordance with the environmental regulations applicable at the location of the operation.

List of figures

10 List of figures

<i>Figure 3-1: Example illustration of a butterfly valve</i>	14
<i>Figure 3-2: Example illustration of a throttle valve</i>	15
<i>Figure 3-3: Nameplate</i>	16
<i>Figure 4-1: Attachment to the crane lugs</i>	19
<i>Figure 4-2: Attachment to the flange holes</i>	19
<i>Figure 4-3: Attachment to the actuator</i>	20
<i>Figure 4-4: Attachment through the valve body</i>	20
<i>Figure 5-1: Position in the pipeline / 1</i>	22
<i>Figure 5-2: Position in the pipeline / 2</i>	23
<i>Figure 5-3: Butterfly valve cross section</i>	24
<i>Figure 7-1: Grease block chamber</i>	30
<i>Figure 7-2: Gland</i>	31

11 List of tables

<i>Table 3.1-1: Parts list for the butterfly valve</i>	14
<i>Table 3.4-1: Details of the nameplate</i>	17

12 Index

A

Abbreviations.....	1
Accidents.....	13
Actuator.....	26
Attaching the valve.....	18

B

Butterfly valve.....	14
Function.....	15
Illustration.....	14
Structure.....	14

C

Commissioning.....	28
Copyright.....	1

D

Declaration of conformity.....	1
Deinstallation.....	22, 24
Disposal.....	34

E

Elastomers.....	21
Electric actuator.....	27
Operation.....	29
Event of danger.....	13
Expert personnel.....	6

F

Fault table.....	33
Faults.....	32
Flow direction.....	24
Flow protection.....	16
Foreseeable misuse.....	4

G

Gland packing.....	16, 31
Gland readjustment.....	31
Grease block chamber.....	16, 30

H

Handwheel.....	26
Operation.....	29
Hazards	
electrical.....	10
mechanical.....	8
posed by ignoring ergonomic principles.....	12
posed by noise.....	11
thermal.....	11
Heating jacket.....	16, 26
Hydraulic actuator.....	27
Operation.....	29

I

Installation.....	22, 24
Installation position.....	23
Intended use.....	4

L

Limit stop.....	16, 25
Limitation of liability.....	3
Lubricating bearings.....	16

M

Maintenance.....	30
------------------	----

N

Nameplate.....	16
----------------	----

O

Operation.....	28
----------------	----

P

Packaging.....	21
PED.....	1
Personal protective equipment.....	7
Personal qualifications.....	6
Personnel requirements.....	6
Pneumatic actuator.....	27
Operation.....	29
Position in the pipeline.....	22
PPE.....	7
Pressure direction.....	24
Pressure Equipment Directive.....	1
Pressure test.....	28
Protective workwear.....	7

R

Recommissioning.....	34
Residual risks.....	7
Responsibilities.....	5
Responsibility of personnel.....	5
Responsibility of the operator.....	5
Risks posed by fire.....	12
Risks posed by materials and substances.....	11
Rubber lining.....	16, 21, 24

S

Safety.....	4
during operation.....	28
Safety information.....	2
Shaft orientation.....	23
Shutdown.....	29
Signs.....	1
Special equipment.....	16
Special paints.....	16

Index

Specialist personnel	6	Type A-Hy	15
Storage.....	21	Type A-Pn	15
Stroke limitation.....	16, 25	Type AR	15
T		Type AS	15
Throttle valve.....	15	Type D	15
Function	16	U	
Illustration	15	Unauthorised individuals	6
structure	15	W	
Thrust bearings	16, 23	Warnings.....	2
Training	6	Warranty	3
Transport.....	17	Warranty conditions	3
Transport inspection.....	18	Wear parts	3
Transport symbols.....	18	Welding work.....	12
Transporting the valve.....	18		
Type A.....	14		

A series of horizontal dashed lines for taking notes.

Quality.
Out of tradition and conviction.

